



HFD / HFP Series Air Handler Installation Instructions



March 2014

HFD / HFP Series Horizontal Air Handler

Installation – Operation – Maintenance

The HFD / HFP Series is designed for horizontal recessed installations in a furred down area, above a suspended ceiling or recessed in the ceiling. The HFD model is for electric heat with DX cooling. The HFP is used for heat pump applications. Installation slots are built into the cabinet to facilitate mounting the unit. Electric resistance heaters are available.

Installation Instructions

Installation of this unit shall be made in accordance with the National Electric Code, NFPA No. 90A and 90B, and any other local codes or utilities requirements.

Warning:

Due to possible damage to equipment or personal injury, installation, service and maintenance should only be performed by a trained, qualified person. Consumer service is recommended only for filter replacement.

Warning:

Ensure all power is disconnected before installing or servicing this unit. More than one disconnect device may be required to de-energize the equipment. Hazardous voltage can cause severe personal injury. Make certain all panels are in place before operating this unit.

Warning: The United States Environmental Protection Agency (EPA) has issued various regulations regarding the introduction and disposal of refrigerants in this unit. Failure to follow these regulations may harm the environment and can lead to the imposition of substantial fines. Because these regulations may vary due to the passage of new laws, we suggest that any work on this unit be done by a certified technician.

Unpacking

Carefully unpack the unit and inspect the contents for damage. If any damage is found at the time of delivery, proper notification and claims should be made with the carrier who delivered the unit. Caution should be used when lifting the unit to **avoid lifting by the blower wheels.** Improper handling can damage the blower wheel causing excessive vibration during operation.

Check the rating plate to assure model number and voltage, plus any kits agree with what you ordered. The

Manufacturer should be notified within 5 days of any discrepancy or parts shortage.

Location

The HFD and HFP series is designed to be installed in a recessed area, (furred down) between floors, ceiling/attic area or hung in an acoustic tile ceiling. Units may be installed in hallways, over bathrooms, or in a commercial drop-in ceiling. These units are designed for indoor use only in a horizontal position.

**AllStyle Coil Company, LP
7037 Brittmore
Houston, TX 77041
Phone 713-466-6333 Fax 713-466-6363**

HFD / HFP Series Air Handler Installation Instructions

This unit is approved for "0" clearance from any side, front, rear or duct work. The unit must be installed in a level position to ensure proper condensation drainage. Make sure the unit is level in both directions within 1/8".

The unit incorporates installation tabs that mount to the framing and provide a 1/2 inch flange to trim to the finished edge of a sheet rock ceiling. The access panel mounts to the cabinet and trims the installation.

Before attempting installation, the following points must be considered:

- Structural strength of supporting members
- Clearances and provision for servicing
- Power supply and wiring
- Air duct connection
- Drain facilities and connections

Duct Work

The duct work should be installed in accordance with the NFPA No. 90A "Installation of Air Conditioning and Ventilating systems" and No. 90B "Residential Type Warm Air Heating and Air Conditioning Installation."

The duct work should be insulated in accordance with the applicable requirements for the particular type installation as required by HUD, FHA, VA the applicable building code, local utility or other governing body.

Condensate Drain

The unit is supplied with 3/4 inch primary and auxiliary condensate drains. Both drains must be trapped outside the unit and piped in accordance with applicable building codes. Do not reduce the drain line size less the connection size on the drain pan. Condensate should be piped to an open drain or to the outside. All drains must pitch downward away from the unit a minimum of 1/8" per foot of line to ensure proper drainage. **PVC glue is not approved or recommended on drain pan fittings, If required, use only 100% Teflon thread sealant or Teflon tape. Caution: Do not over tighten the fitting. Note: there are two small pieces of duct sealant putty in the bottom corners on the air discharge side of the drain pan. It is important that you seal the small air gap between the drain pan and the ductwork to prevent water from splashing out of the pan during AHU operation.**

Refrigerant Piping

Refrigerant pipe connections are located on the top of the unit. Refrigerant piping external to the unit shall be sized in accordance with the instructions of the manufacturer of the outdoor equipment. When units are recessed mounted in the wall, make certain that piping connections are pressure tested prior to the wall being closed. **Manufacturer dose not insulate the expansion valve distributor tubes or liquid lines coming from manifold. It is the sole responsibility of the contractor to properly insolate from condensation.**

(YOU MUST INSULATE THE REFRIGERANT LINES AND TXV UP TO WERE THE PAN CATCHES ALL CONDENSATE DRIPS.)

Metering Device

All units are shipped with a check-flow piston installed which is designed for air conditioning or heat pump operation. If your application requires a thermal expansion valve or check expansion valve then it is necessary to remove the piston from the distributor assembly and install the proper metering device. Be sure to follow the instruction in the kit to ensure proper installation.

Wiring

Consult all schematic and pictorial wiring diagrams of this unit and the outdoor equipment to determine compatibility of the wiring connections and to determine specific requirements.

All field wiring to the blower coil should be installed in accordance with the latest edition of the National Electric Code NFPA No. 70 and any local codes.

Check rating plates on unit for rated volts, minimum circuit ampacity and maximum over current protection. Supply circuit power wiring must be 75 degree C. (167 degree F) minimum copper conductors only. Copper supply wires shall be sized to the National Electric Code or local code requirements, whichever is more stringent.

The unit is shipped wired for 230/240 Volt AC 60 HZ 1 Phase Operation. If the unit is to operated at 208 VAC 60HZ, then follow the instruction on the indoor unit wiring diagram to change the low voltage transformer to 208 VAC operation.

Be sure the unit is properly grounded.

Class 2 low voltage control wiring should not be run in conduit with power wiring and must be separated from power wiring, unless class 1 wire of proper voltage rating is used. Low voltage control wiring should be 18 Awg, color coded (105 degree C minimum). For lengths longer than 100ft., 16 Awg wire should be used. Make certain

HFD / HFP Series Air Handler Installation Instructions

that separation of control wiring and power wiring has been maintained.

Thermostat

Select a thermostat that is commonly referred to as a single stage cooling with electric heat sub base. This stat will energize the fan on a demand for heat or cool.

Install the thermostat on an inside wall, away from drafts, lights or other heat sources in a location that has good air circulation from the other rooms being controlled by the thermostat. The thermostat should be mounted 4 to 5 feet above the floor.

Sequence of Operation

Cooling (cooling only or heat pump with reversing valve energized in heat mode). When the thermostat calls for cooling, the blower relay is energized. The N.O. contacts will close, after a time delay, the indoor blower will operate. The circuit between R and Y is completed: causing the contactor on the outdoor equipment to close and start the compressor and the outdoor fan motor.

Cooling (heat pump with reversing valve energized in cooling mode). When the thermostat calls for cooling, the circuit between R and G and R and O is completed. Circuit R and O energizes the reversing valve to the cooling position, Circuit R and G energizes blower relay. The N.O. contacts will close, after a time delay, the indoor blower will operate. The circuit between R and Y is completed: causing the contactor on the outdoor equipment to close and start the compressor and the outdoor fan motor.

Heating (electric heat only). When the thermostat calls for heat, the circuit between R and W is completed, the heat sequencer is energized. A time delay will occur: Then the heating element(s) and the indoor blower motor will come on.

Heating (heat pump reversing valve energized in heat mode). When the thermostat calls for heat, the circuits between R and B, R and Y and R and G are completed. Circuit R and B energize the reversing valve switching it to the heat position. Circuit R and Y energized the outdoor unit contactor starting the compressor and outdoor fan. Circuit R and G energizes the blower relay starting the blower motor.

If the indoor room temperature should continue to fall, circuit R and W2 is by the second-stage heat bulb on the thermostat. Circuit R-W2 energizes the heat sequencer.

The completed circuit will energize the supplemental electric heat.

Blower Time Delay. This unit is equipped with timed on and a timed off relay. This relay delays the start and delays the stopping of the indoor fan motor to maximize the efficiency of the unit.

Defrost. Supplemental heat during defrost can be provided by connecting B on the blower coil to the defrost relay on the outdoor heat pump. This will complete the circuit between R and B (in the blower coil) through a set of contacts in the defrost relay in the outdoor unit when the unit starts the defrost cycle. This circuit, when it is connected, will help prevent cold air from being discharged from the indoor unit during the defrost

Blower

Units through three tons are supplied with a multi-speed (high, medium & low) motor with direct drive blower wheel which can obtain various air flows. One and one half ton units are factory wired on low speed, two ton units are factory wired on medium speed and two and one half ton units are factory wired on high speed. If a different motor speed is required, disconnect all power to the unit, remove the factory wired indoor fan motor lead from the fan relay and place an insulated cap on the removed motor lead. Remove the insulated cap from the desired indoor fan motor lead, place a spade connector on the lead and connect it to the fan relay where the original lead was connected. The black motor lead is high speed, the red motor lead is low speed, and the blue motor lead (if available) is medium speed. Be sure to check the air flow and the temperature drop across the evaporator coil to ensure that you have sufficient airflow.

Start Up

Once all connections are completed, the unit should be started up and a check out of the completed system should be performed. Before performing any system test, make sure that all grilles, registers and dampers are open and set to the correct position. Also make certain that an air filter is installed in the return air prior to running the air handler.

A performance test should be completed in accordance with the outdoor equipment manufacturer's instructions. Airflow tests should be conducted in the heating and cooling modes to ensure satisfactory operation.

Maintenance

The system air filter(s) should be inspected, cleaned or replaced at least monthly. If the filter is mounted internal

HFD / HFP Series Air Handler Installation Instructions

to unit, make sure that electrical power is disconnected before removing the access panels. Make certain that the access panels are replaced and secured properly before placing the unit back in operation. This product is designed for dependable service; however, periodic maintenance should be scheduled to be conducted by trained professional service personnel. This service should be conducted at least annually, and should include testing and inspection of electrical and refrigerant components. The heat transfer surface should be cleaned. The blower motor is permanently lubricated for normal operating conditions.

Warnings

Do not store or use any corrosives or combustibles in the vicinity of this unit. All panels must be in place and properly secured before operating this equipment.

All electrical power servicing this unit must be disconnected prior to removal of any panels. Service of this unit must be accomplished by qualified trained professional personnel only

Conforms to UL STD 1995

THIS UNIT IS MANUFACTURED IN THE USA BY:

AllStyle Coil Co., LP
7037 Brittmore
Houston, TX 77041

CEILING ACCESS PANELS						
FOR	PANEL	DESCRIPTION	CEILING		PANEL FRAME	
			PANEL	OPENING	DIMS. (OUTSIDE)	
MODEL	NO.					
30" Coil	PL-3975	LOUVERED	24-1/2"	40"	28"	43-3/4"
	PS-3975	NON-LOUVERED	24-1/2"	40"	28"	43-3/4"
36" Coil	PL-4575	LOUVERED	24-1/2"	46"	28"	49-3/4"
	PS-4575	NON-LOUVERED	24-1/2"	46"	28"	49-3/4"
42" Coil	PS-5175	LOUVERED	24-1/2"	52"	28"	55-3/4"
	PS-5175	NON-LOUVERED	24-1/2"	52"	28"	55-3/4"

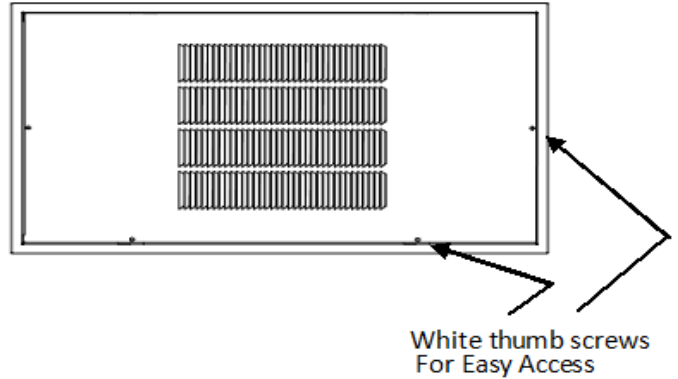

ENCLOSURE CONNECTION LOCATIONS

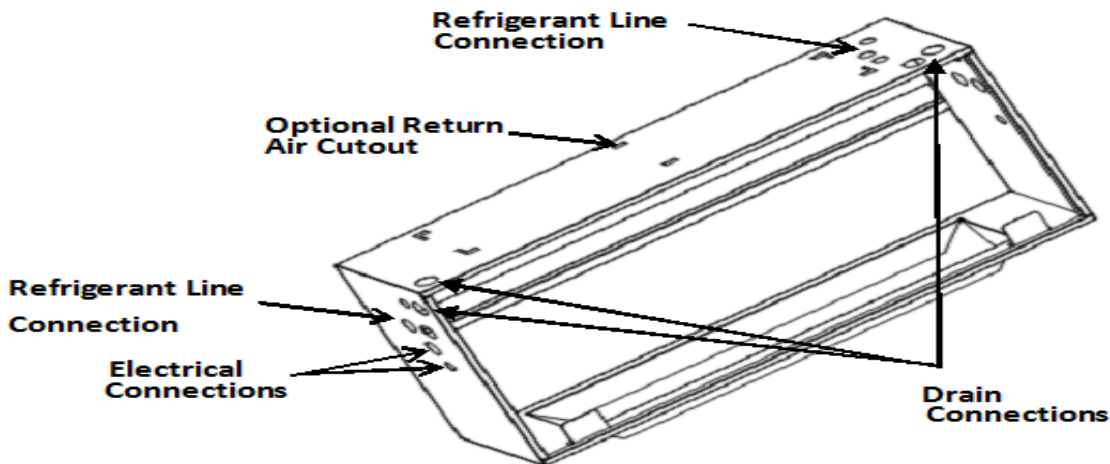

Housing with Ceiling Panels

(Housings and panels are standard with ALL “-H” models or can be ordered separately as a accessory kit)

CEILING PANEL/ENCLOSURE INFORMATION										
FOR MODEL	HOUSING NO.	HOUSING DIMENSIONS			FOR MODEL	PANEL NO.	DESCRIPTION	CEILING PANEL OPENING		PANEL FRAME DIMS. (OUTSIDE)
		H	W	D						
30" Coil	3975	11"	39-3/4"	24"	12,18,24	PL-3975	LOUVERED	24-1/2"	40"	28" 43-3/4"
					30 HF	PS-3975	NON-LOUVERED	24-1/2"	40"	28" 43-3/4"
36" Coil	4575	11"	45-3/4"	24"	36 HF	PL-4575	LOUVERED	24-1/2"	46"	28" 49-3/4"
						PS-4575	NON-LOUVERED	24-1/2"	46"	28" 49-3/4"
42" Coil	5175	11"	51-3/4"	24"	37 HF	PL-5175	LOUVERED	24-1/2"	52"	28" 55-3/4"
						PS-5175	NON-LOUVERED	24-1/2"	52"	28" 55-3/4"

(See panel pictures above)

NOTES:

- These housings are shipped with units installed unless specified otherwise.
- Customer needs to specify on order which panel is wanted.

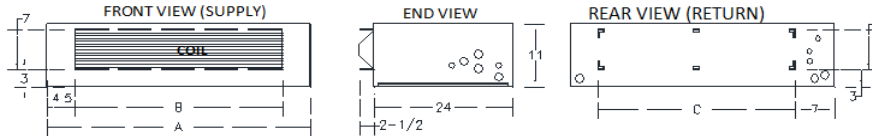

ENCLOSURE DIMENSIONS				
FOR MODEL	ENCLOSURE NO.	A	B	C
30" Coil	3975	39-3/4	30-5/8	30-5/8
36" Coil	4575	45-3/4	36-5/8	36-5/8
42" Coil	5175	51-3/4	42-5/8	42-5/8



KNOCKOUT FOR DUCTED RETURN
(Requires filter grille-field supplied)
(Ducted return requires non-louvered panel)



Expansion valve kit (Heat pump and Cooling only)		
PART NO.	TYPE	FOR
RP31114	R-410A	1-2 Tons
RP31115	R-410A	2.5-3 Tons
RP31117	R-410A	1-2 Tons
RP31118	R-410A	2.5-3 Tons

Heat Strip Kit		
PART NO.	KW MODELS	
RP16215	3 KW	Requires (2) 1.5 Kw Elements
RP16220	4 KW	Requires (2) 2.0 Kw Elements
RP16224	5 KW	Requires (2) 2.4 Kw Elements
RP16230	6 KW	Requires (2) 3.0 Kw Elements
RP16240	8 KW	Requires (2) 4.0 Kw Elements
RP16248	10 KW	Requires (2) 4.8 Kw Elements

Notes:
 Expansion valve kits are approved for both heat pump or cooling only (non heat pump) applications.
 Valves are factory installed or field installed.
 Contractor friendly screw-on connections.
 Valves are external equalizing, internal bleed.
 +V For cooling only valves Ex.HF18-30840G+V+5+H
 +VP For heat pump model valves Ex. HF18-30840G+VP+5+H

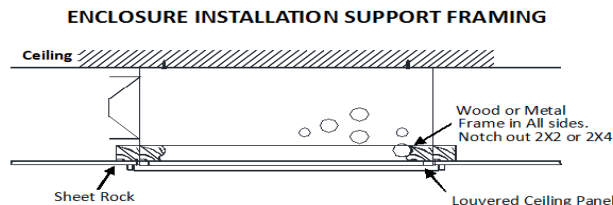

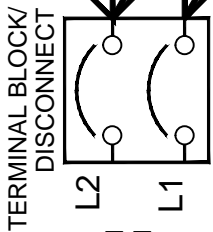

CIRCUIT NO.1
208-230/60/1



USE COPPER CONNECTORS ONLY.
Use Conductors Suitable for 167 Deg F.
208-230VAC / 60Hz / 1Ph

EQUIPMENT GROUND USE COPPER OR ALUMINUM WIRE.

NOT ALL MODELS USE FUSE LINKS

2 SPEED FAN CONTROL
Not all motors have 3 speeds

Black - High Speed
Blue - Medium Speed
Red - Low Speed

TDR - TIME DELAY RELAY

⚠ WARNING
DISCONNECT POWER BEFORE
INSTALLATION OR SERVICING.
MULTIPLE POWER SOURCES
MAY BE PRESENT.
FAILURE TO DO SO MAY
CAUSE PROPERTY DAMAGE,
PERSONAL INJURY, OR DEATH.

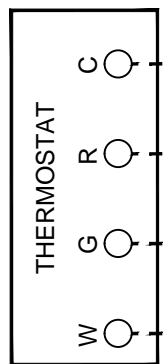

**Air Handler with 10kW
Heating Elements or Less
and 2 Speed Fan Control**

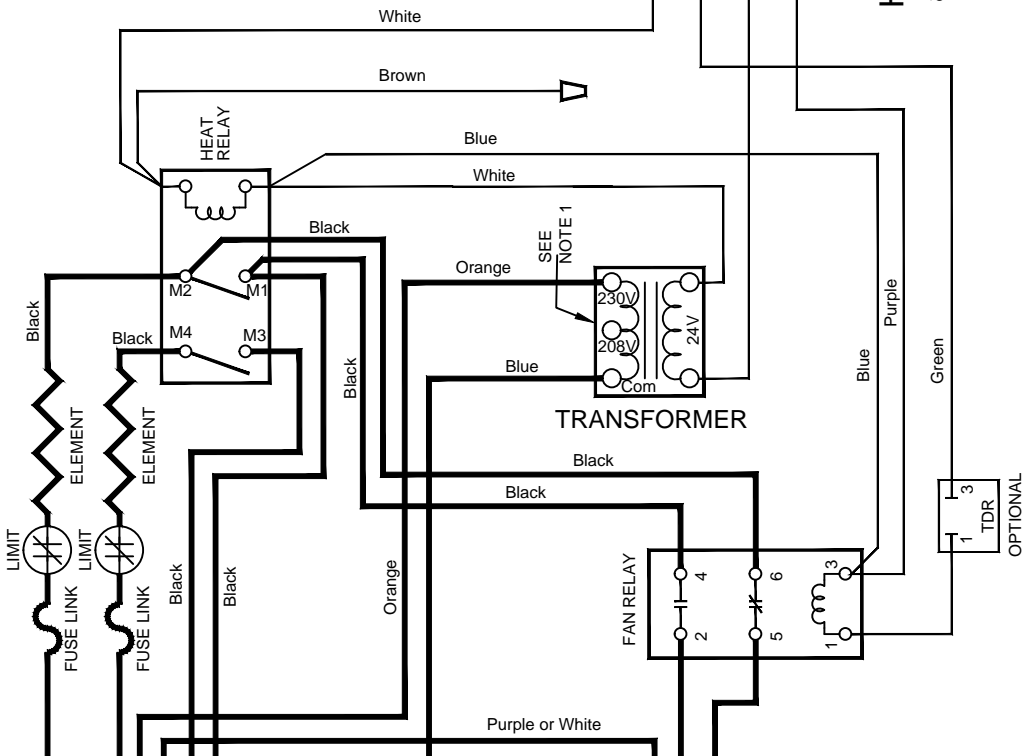

WIRING TABLE	FACTORY WIRING	FIELD WIRING
HIGH VOLTAGE WIRING	—————	- - - - -
LOW VOLTAGE WIRING	—————	- - - - -
CONSULT NATIONAL CODE FOR PROPER WIRE SIZE.		
NOTE 1) Wiring change is required to convert transformer to 208 Volts. Disconnect power. Disconnect orange high voltage lead and place on terminal labeled as "208V" for 208 Volts power.		



AW1201-55324